



ACECO

GUÍA DEL HERRERO

HERRERÍA
Y FORJA ARTÍSTICA





FORJA ANTIGUA MARTILLADA



fig.
C-1-M
16.0 x 12.0 cms.



fig.
C-2-M
21.0 x 12.0 cms.



fig.
C-3-M
12.0 cms. Ø



fig.
C-4-M
16.0 cms. Ø



fig.
C-5-M
17.5 x 12.0 cms.



fig.
C-6-M
17.5 x 15.0 cms.



fig.
C-9-M
61.5 x 12.0 cms.



fig.
C-7-M
36.0 x 12.0 cms.



fig.
C-8-M
33.0 x 12.0 cms.





FORJA ANTIGUA



fig.
C-1
16.0 x 12.0 cms.

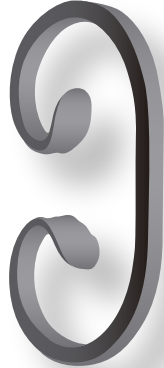

fig.
C-2
21.0 x 12.0 cms.



fig.
C-3
12.0 cms. Ø



fig.
C-4
16.0 cms. Ø



fig.
C-5
17.5 x 12.0 cms.



fig.
C-6
17.0 x 15.0 cms.



fig.
C-9
61.5 x 12.0 cms.



fig.
C-10
61.5 x 12.0 cms.



fig.
C-7
36.0 x 12.0 cms.



fig.
C-8
33.0 x 12.0 cms.





FORJA BARROCO



fig.
B-1
16.8 x 12.0 cms.



fig.
B-2
21.0 x 12.0 cms.



fig.
B-3
16.0 x 12.0 cms.



fig.
B-4
16.0 x 12.0 cms.



fig.
B-5
39.0 x 21.0 cms.



fig.
B-6
39.0 x 22.5 cms.



fig.
B-7
45.2 x 14.9 cms.



fig.
B-8
27.7 x 17.0 cms.

OPCIONAL:
LAS FIGURAS B- 8 PUEDEN
TENER LA TERMINACIÓN CON
ESFERA DE 1 DE Ø

OPCIONAL:
TODAS LAS FIGURAS BARROCO,
SE ENCUENTRAN EN PRESENTACIÓN
LISA Y MARTILLADA.

EL MATERIAL EMPLEADO EN TODAS LAS FIGURAS ES DE VARILLA DE 1/2"





MÓDULO CONTEMPORANEO

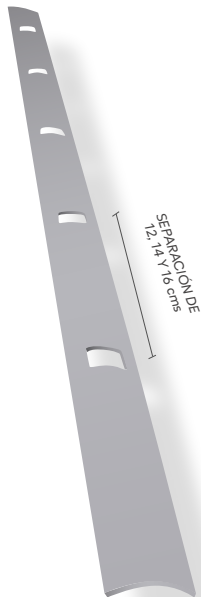

**CANALETA
PERFORADA**
DE 1 1/8" DE ANCHO
EN CALIBRE DE 12
EN TRAMOS DE 3 METROS

**SUPREMA
EXTRA RESISTENCIA**

CON PERFORACIÓN DE
1/2" Y 5/8" EN PRESENTACIÓN
CUADRADO Y REDONDO

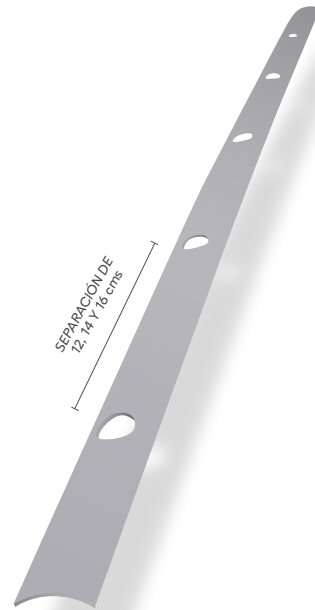

MÓDULO
CONTEMPORANEO
No. 1
90.0 x 16.0 cms.



MÓDULO
CONTEMPORANEO
No. 2
90.0 x 16.0 cms.



MÓDULO
CONTEMPORANEO
No. 3
90.0 x 20.3 cms.

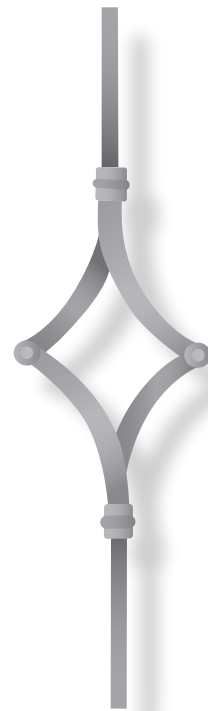

MÓDULO
CONTEMPORANEO
No. 4
90.0 x 10.0 cms.





LÍNEA MILENIO



FIG. X
59.0 x 8.0 cms.



FIG. X1
34.0 x 8.0 cms.



FIG. A
20.0 x 8.0 cms.



FIG. B
16.0 x 8.0 cms.



FIG. A1
20.0 x 8.0 cms.



FIG. C
23.5 x 8.0 cms.



FIG. CC
33.5 x 12.0 cms.

**NOTA:
EL MATERIAL EMPLEADO EN
TODAS LAS FIGURAS ES DE
SOLERA DE CALIBRE
9 Y 1/8" X 1/2"**

**NOTA:
EL MATERIAL EMPLEADO EN
LAS FIGURAS TAURO
ES DE SOLERA CALIBRE
9 Y 1 1/4"**



FIG. TAURO
20.7 x 32.0 cms.

TABLA DE PESOS TEORICOS APROXIMADA

FIG.	PESO EN GRAMOS	FIG.	PESO EN GRAMOS	FIG.	PESO EN GRAMOS	FIG.	PESO EN GRAMOS
A	0.175	R	0.450	T1	0.351	W	0.450
A1	0.175	R1	0.385	U	0.441	W1	0.395
B	0.244	S	0.441	U1	0.315	X	0.411
C	0.267	S1	0.315	V	0.441	X1	0.324
CC	0.324	T	0.441	V1	0.324		





SOLERA

VARILLA ARTISTICA DE 1/2" ∇

Torcido cada 20.0 cms. Tramos de 6.0 mts.

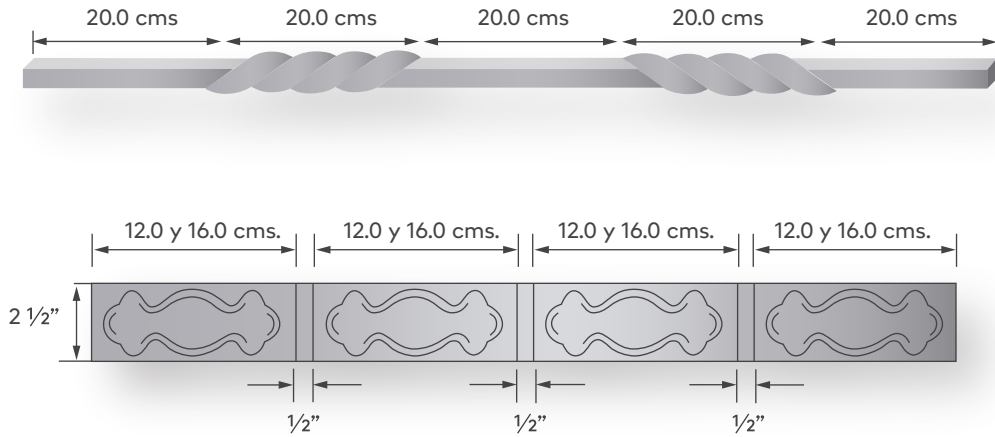

SOLERA ARTISTICA N°. 1 a cada 12 cms
Tramos de 3.0 mts.

SOLERA ARTISTICA N°. 2 a cada 16 cms.
(calibre 14)

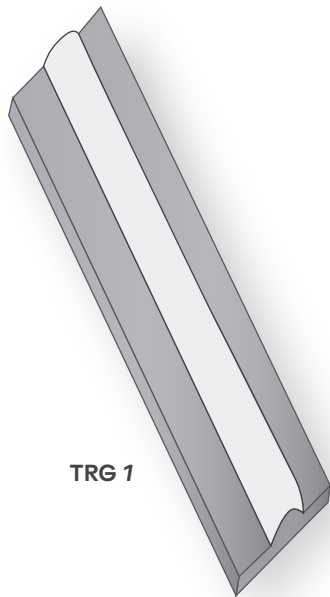

TRG 1

TIRA REFORZADA PARA GRAPA
Tramos de 3.0 mts.
(calibre 17)

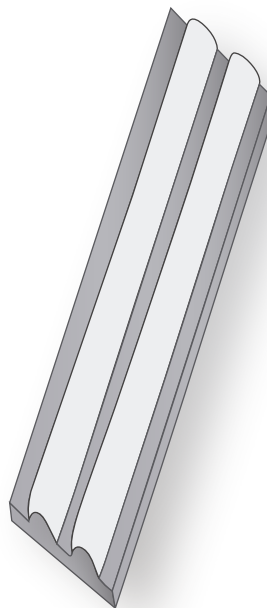

TRG 2

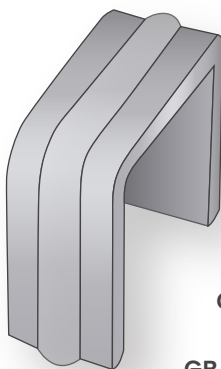

GR 1

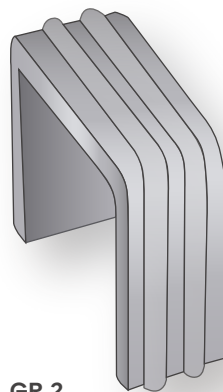

GR 2

GRAPA REFORZADA

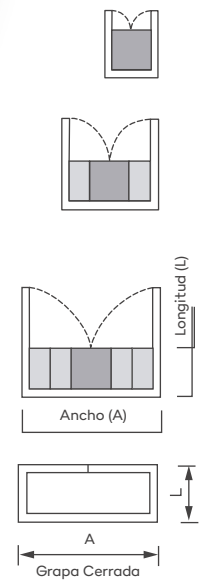

INDIVIDUAL
(calibre 17)

- 1/2" (A) x 1/2" (L)
- 1" (A) x 1/2" (L)
- 1 1/2" (A) x 1/2" (L)





ROSETONES

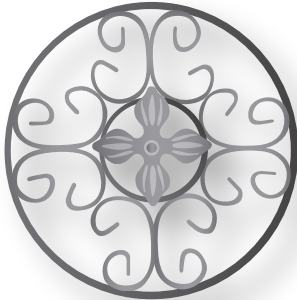

ROSETON CORINTIO
33.5 CMS.
DIAMETRO

**PRODUCTO
NUEVO**



ROSETON COTORRO
33.5 CMS.
DIAMETRO

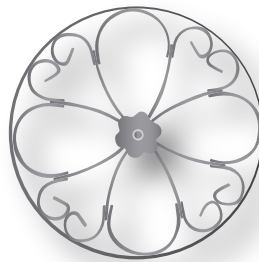

ROSETON FORTUNA
33.5 CMS.
DIAMETRO

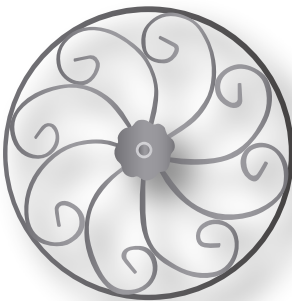

ROSETON FLOR
33.5 CMS.
DIAMETRO

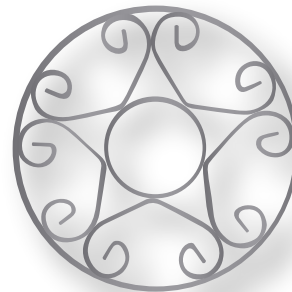

ROSETON ESTRELLA
33.5 CMS.
DIAMETRO



ROSETON
26.0 CMS.
DIAMETRO



ROSETON PAJARO
33.5 CMS.
DIAMETRO



ROSETON TUCAN
33.5 CMS.
DIAMETRO





LÍNEA DE MÓDULOS



MÓDULO 4
6.0 cms. (A)
90.0 cms. (L)



MÓDULO 5
26.0 cms. (A)
90.0 cms. (L)

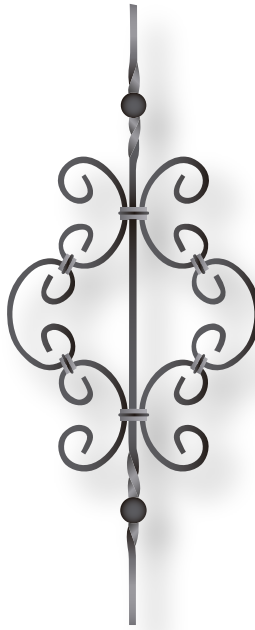

MÓDULO 6
27.3 cms. (A)
90.0 cms. (L)



MÓDULO 7
23.5 cms. (A)
90.0 cms. (L)

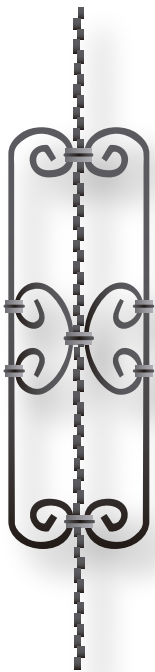

MÓDULO 8
16.5 cms. (A)
90.0 cms. (L)

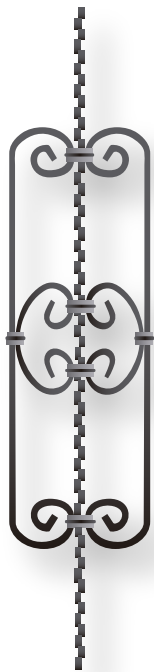

MÓDULO 9
16.5 cms. (A)
90.0 cms. (L)



MÓDULO 10
12.0 cms. (A)
90.0 cms. (L)



MÓDULO 11
5.0 cms. (A)
90.0 cms. (L)



MÓDULO 12
8.0 cms. (A)
90.0 cms. (L)





LÍNEA DE MÓDULOS



MÓDULO 13
17.5 cms. (A)
90.0 cms. (L)



MÓDULO 14
8.0 cms. (A)
90.0 cms. (L)



MÓDULO 15
7.5 cms. (A)
90.0 cms. (L)



MÓDULO 16
17.3 cms. (A)
90.0 cms. (L)



MÓDULO 17
7.9 cms. (A)
9.9 cms. (L)



MÓDULO 18
24.0 cms. (A)
45.7 cms. (L)



MÓDULO 19
19.8 cms. (A)
42.6 cms. (L)

ACERO FORJDO

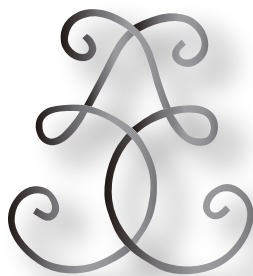

MÓDULO 20
36.3 cms. (A)
39.3 cms. (L)

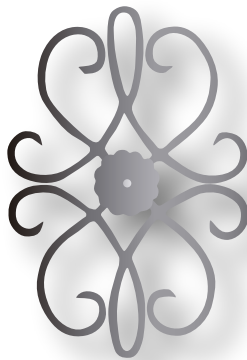

MÓDULO 21
33.3 cms. (A)
48.0 cms. (L)



MÓDULO 22
20.0 cms. (A)
90.0 cms. (L)

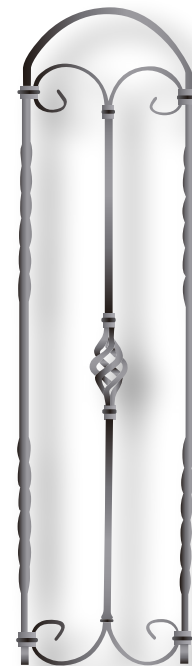

MÓDULO 23
23.0 cms. (A)
90.0 cms. (L)





FLECHAS DECORATIVAS



LÁMINADA N.º 1
4" X 1"
(calibre 8)

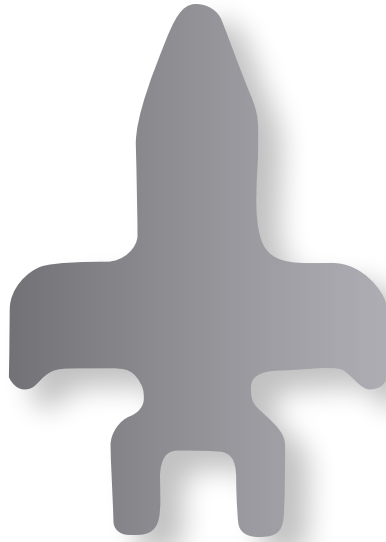

LÁMINADA N.º 2
4" X 2 3/4"
(calibre 8)

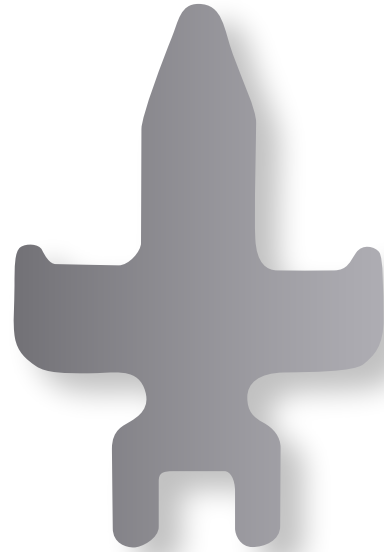

LÁMINADA N.º 3
4" X 2 3/4"
(calibre 8)



LLAMA
4" X 2 1/4"
(calibre 8)



FLAMA
4" X 1 1/2"
(calibre 8)

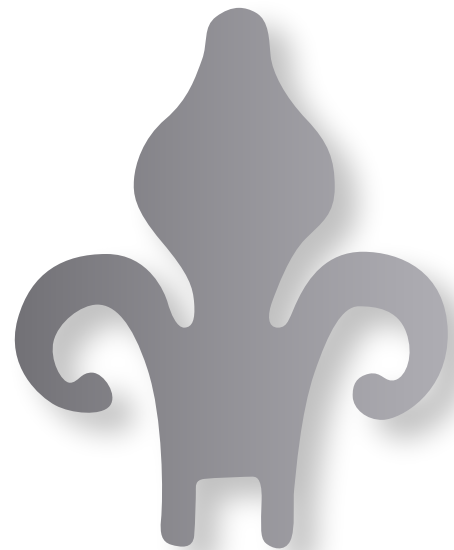

SCOUT
4 1/2" X 3 1/2"
(calibre 8)





FLECHAS DECORATIVAS



FORJADA DE 1/2
4 3/8" X 1 1/8"

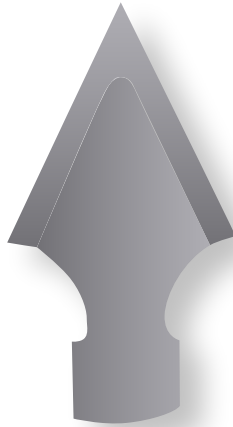

CUPIDO
2 3/16" X 1 5/8"
(calibre 20)



FLECHA PARKER 1
3.4 x 6.0 cms
(calibre 13)



FLECHA PARKER 2
3.4 x 6.0 cms
(calibre 13)

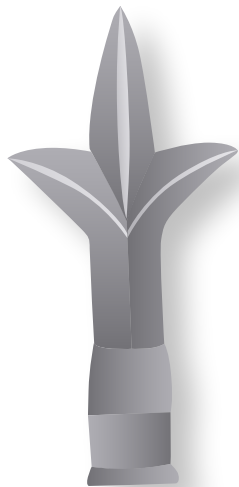

GOTICO LAMINADO
4 1/4" X 2 3/16"
(calibre 20)

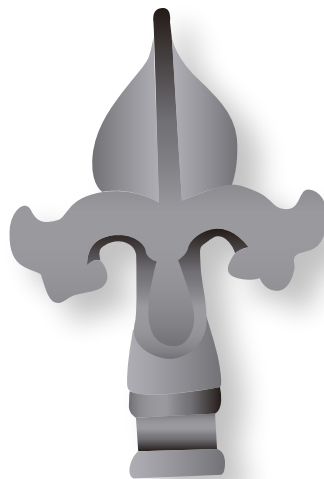

BARROCO LAMINADO
4 3/8" X 2 7/8"
(calibre 20)

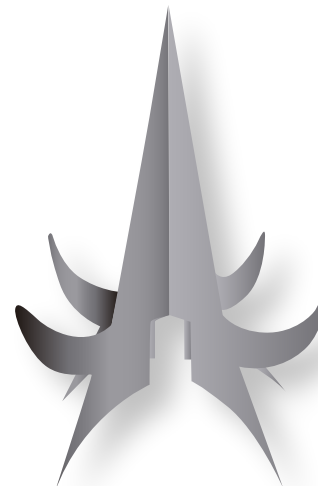

ORIENTAL
3 3/4" X 3 1/8"
(calibre 20)





PIÑAS DECORATIVAS

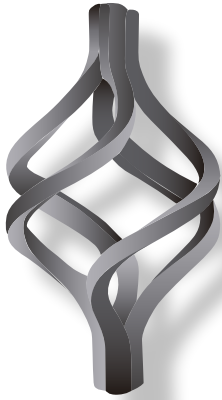

GRIEGA ANTIGUA N°. 1

8.0 X 15.0 cms.
PARA $\square \frac{1}{2}$ "
(Calibre $\frac{1}{4}$ ")



GRIEGA JR. ANTIGUA N°. 2

6.5 x 12.0 cms.
PARA $\square \frac{1}{2}$ "
(Calibre $\frac{1}{4}$ ")



GRIEGA JR. NUEVA N°.3

5.0 x 12.0 cms.
PARA $\square \frac{1}{2}$ "
(Calibre $\frac{1}{4}$ ")



GRIEGA NUEVA N°. 4

6.0 x 15.0 cms.
PARA $\square \frac{1}{2}$ "
(Calibre $\frac{1}{4}$ ")



GRIEGA N°. 5

7.5 x 15.0 cms.
PARA $\square \frac{5}{8}$ "
(Calibre $\frac{3}{16}$ ")



GRIEGA ANTIGUA N°. 1

8.0 X 15.0 cms.
PARA $\square \frac{1}{2}$ "
(Calibre $\frac{1}{4}$ ")



GRIEGA N°. 7

6.5 X 15.0 cms.
PARA $\square \frac{5}{8}$ "
(Calibre $\frac{3}{16}$ ")



GRIEGA N°. 8

8.2 X 4.0 cms.
PARA $\square \frac{3}{8}$ ", $\frac{1}{2}$ "
(Calibre $\frac{3}{16}$ ")



GRIEGA N°. 9

33.0 x 8.0 cms.
28.0 x 6.0 cms.
PARA $\square \frac{1}{2}$ "
(Calibre 14)



IMPERIAL

15.5 x 8.2 cms.
PARA $\square \frac{1}{2}$ "
(Calibre 14)





HERRAJES DECORATIVOS

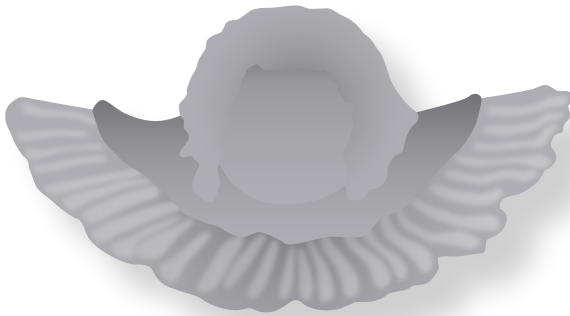

ÁNGEL
(negro y latonado)

CHICO **GRANDE**
16.0 x 8.7 cms. 33.2 x 17.8 cms.

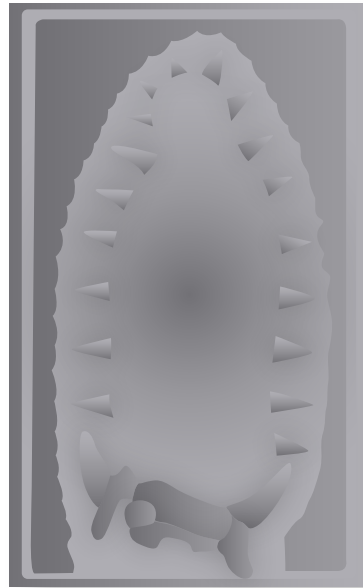

VIRGEN DE GUADALUPE
(negro, colorizado y latonado)
36.5 x 22.2 cms.
(calibre 20)

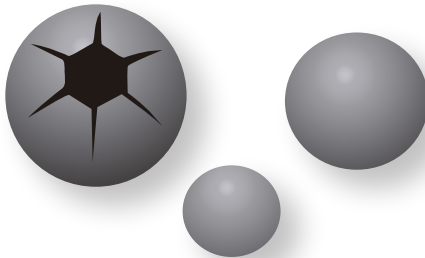

ESFERA PEFORADA
(negro y latonado)
3/4", 1, 1 1/2", 2" y 3" Ø
(calibre 20)

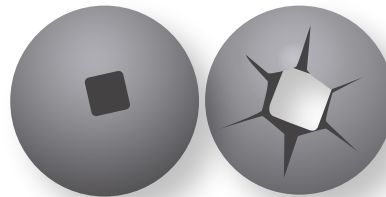

ESFERA PEFORADA
(negro y latonado)
3/4", 1, 1 1/2", 2" y 3" Ø
con 2 Perforaciones de 1/2"
(calibre 20)

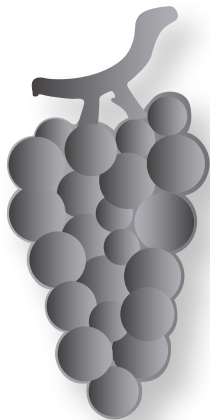

RACIMO DE UVA
14.0 x 6.8 cms.
(calibre 20)

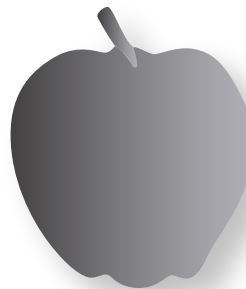

MANZANA
6.0 cms. Ø
(calibre 20)





HOJAS DECORATIVAS

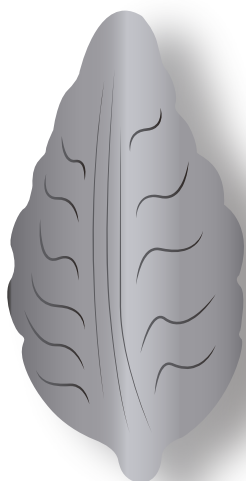

AMAPOLA
11,6 x 6,0 cms.
(Calibre 20)

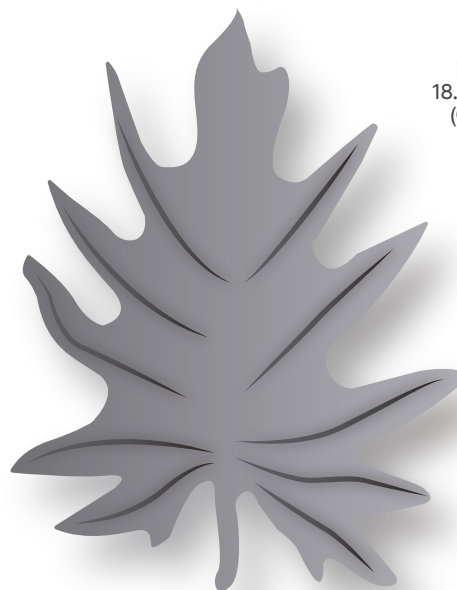

BANDERA
18,0 x 14,0 cms.
(Calibre 20)



BARROCO
20,0 x 6,4 cms.
30,0 x 9,0 cms.
(Calibre 20)



BUGAMBILIA
9,6 x 4,7 cms.
(Calibre 18)



DURAZNO
7,0 x 1,8 cms.
(Calibre 20)

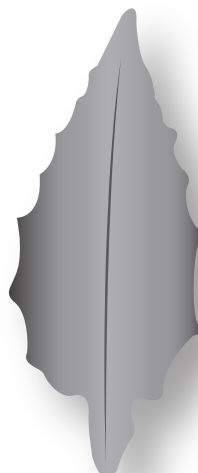

EUCALIPTO
7,2 x 3,0 cms.
(Calibre 20)





HOJAS DECORATIVAS

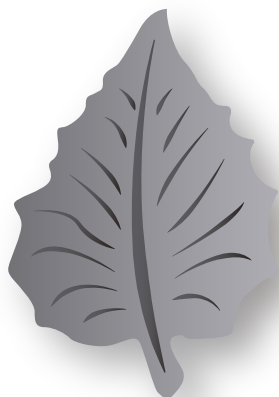

FRESNO
6.7 x 4.7 cms.
(Calibre 20)



GERANIO
16.0 x 14.0 cms.
(Calibre 20)

HELECHO
23.8 x 10.0 cms.
(Calibre 20)

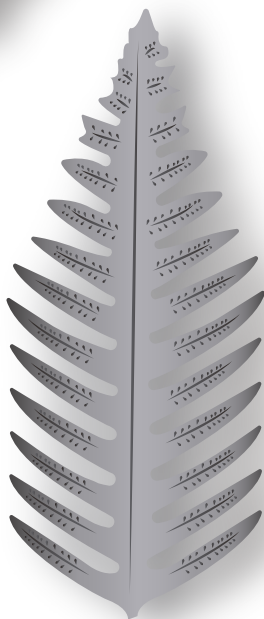

HIEDRA
6.5 x 8.0 cms.
(Calibre 20)



HIGUERA
19.5 x 19.0 cms.
(Calibre 20)

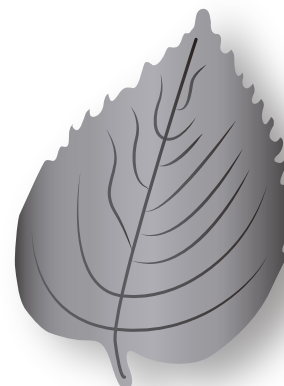

JULIETA
14.3 x 10.2 cms.
(Calibre 20)





HOJAS DECORATIVAS

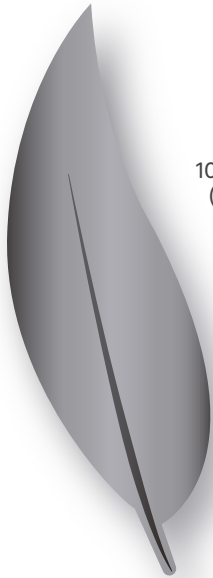

LIMON
10.2 x 3.8 cms.
(Calibre 20)

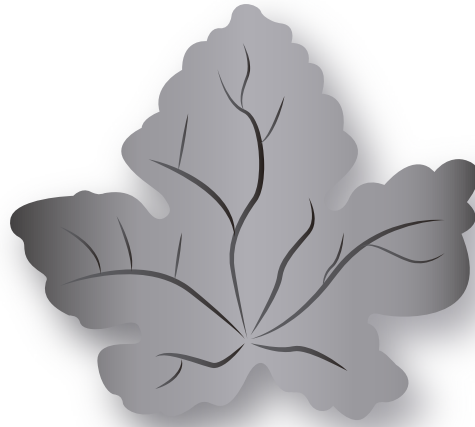

MAPLE
7.0 x 7.8 cms.
(Calibre 18)

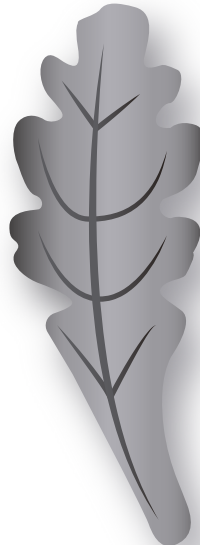

OLIVO
10.0 x 3.6 cms.
(Calibre 18)

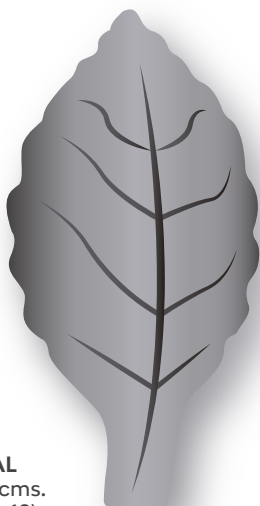

ROSAL
5.5 x 1.7 cms.
(Calibre 18)



VIÑA
6.5 x 8.0 cms.
(Calibre 20)





ANIMALES DECORATIVOS



COTORRO
IZQ. DER.
20.0 x 6.4 cms.
(Calibre 20)

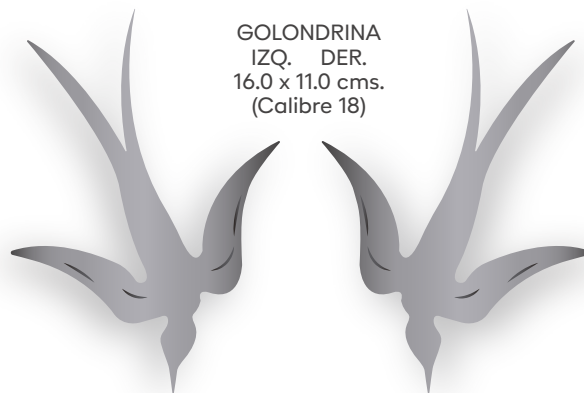

GOLONDRINA
IZQ. DER.
16.0 x 11.0 cms.
(Calibre 18)



LEON
12.6 x 10.1 cms.
(Calibre 20)



LOBO
(NEGRO Y LATONADO)
12.5 x 10.0 cms.
(Calibre 20)

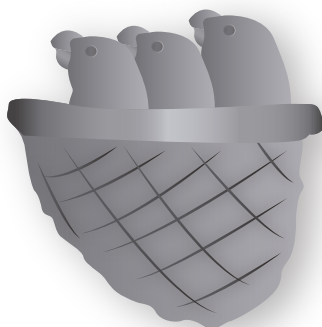

NIDO
12.0 x 11.9 cms.
(Calibre 20)



TUCAN
30.0 x 15.0 cms.
(Calibre 20)



MARIPOSA
10.5 x 9.5 cms.
(Calibre 20)





FLORES DECORATIVAS



ALCATRAZ
CHICO 12.0 x 7.0 cms.
GRANDE 22.0 x 10.8 cms.
 (Calibre 20)

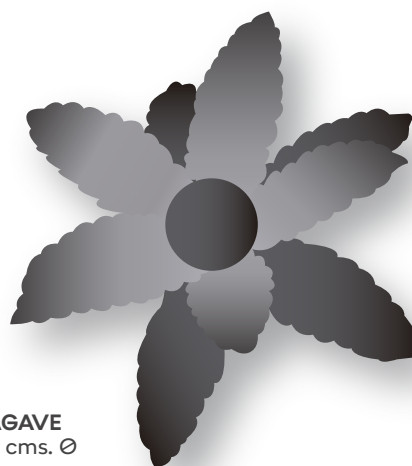

AGAVE
 11.8 cms. Ø

BOTON ROMANO
 4.0 cms. Ø

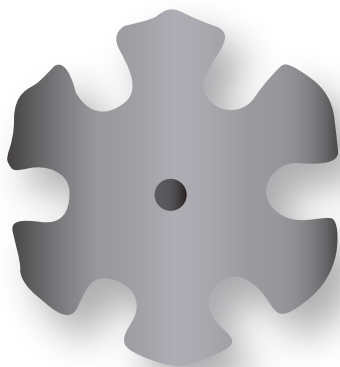

LIRIO
 13.5 cms. Ø

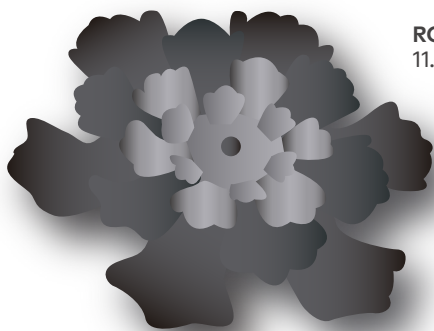
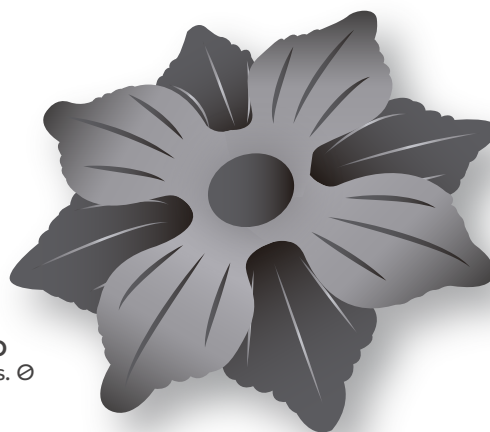

ROMANA 1
 11.5 cms. Ø

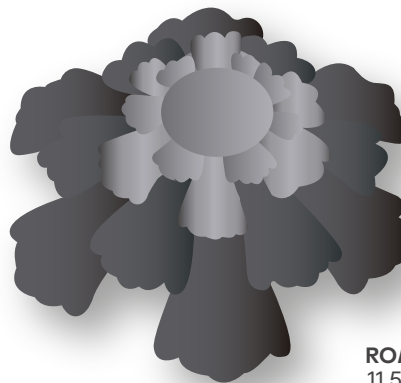

ROMANA 2
 11.5 cms. Ø





FLORES DECORATIVAS

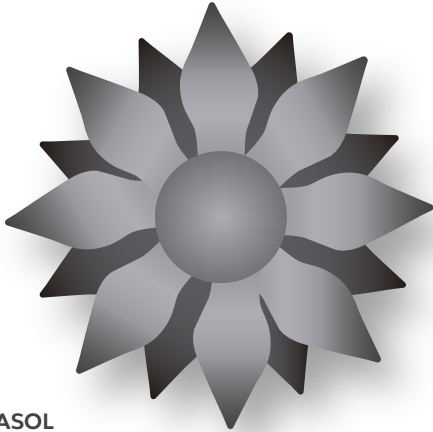

GIRASOL
16.5 cms. Ø
(Calibre 20)

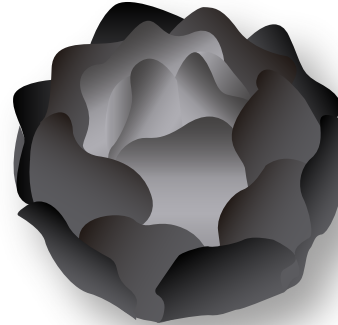

ROSA
6.5 cms. Ø
(Calibre 20)



MACETERO
29.0 x 47.0 cms.



BOTON DE ROSA
6.5 x 4.2 cms.
(Calibre 20)

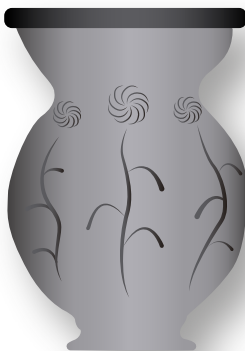
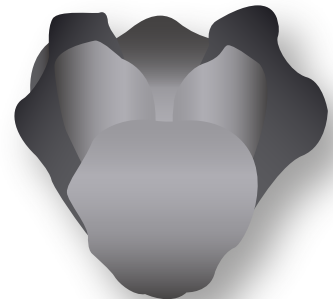

JARRON
GRANDE 35.0 x 24.5
CHICO 16.4 x 11.5
(Calibre 20)



TALLO
TRAMI DE 3.0 mts.
(Alambronde 1/4" Ø)





CHAPETONES DECORATIVOS

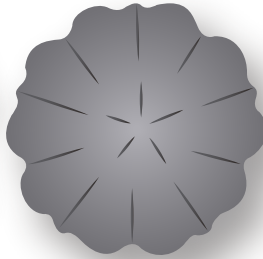
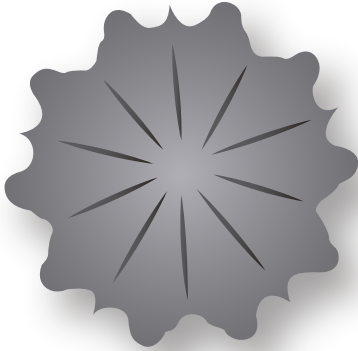

GLADIOLA
GRANDE 3 3/8" Ø
CHICA 2 3/16" Ø

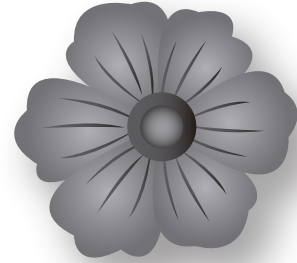

MAGNOLIA
 6.2 cms. Ø

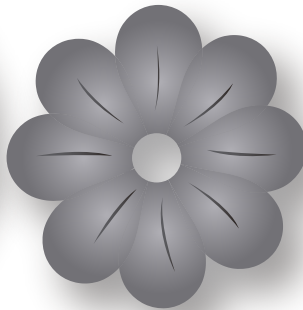
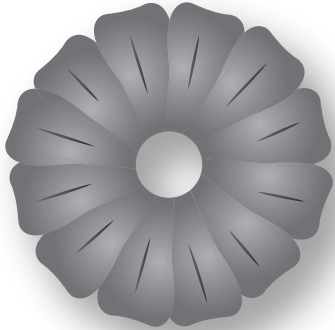

**CHAPETON
 CON REMACHE SUELTO**
GRANDE 3 3/4" Ø
CHICA 2 5/8" Ø

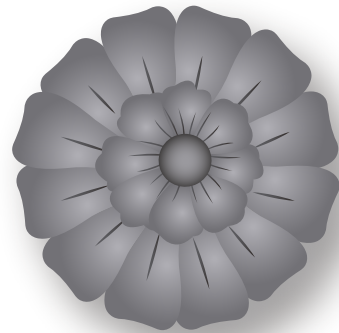

**CHAPETON
 COMBINADO**
 3 3/4" Ø

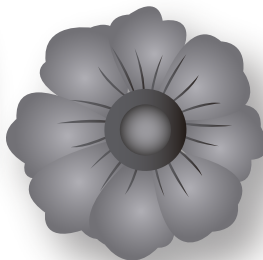
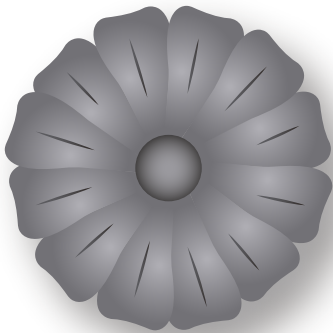

**CHAPETON
 CON REMACHE INTEGRADO**
GRANDE 3 3/4" Ø
CHICA 2 5/8" Ø

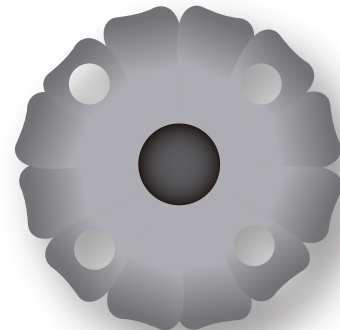

**CHAPETON GRANDE
 PERFORADO**
 3 3/4" Ø





CHAPETONES DECORATIVOS

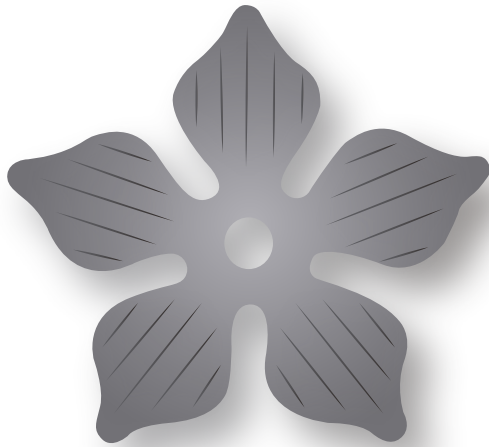

CHAPETON ESTRELLA
3 1/2" Ø

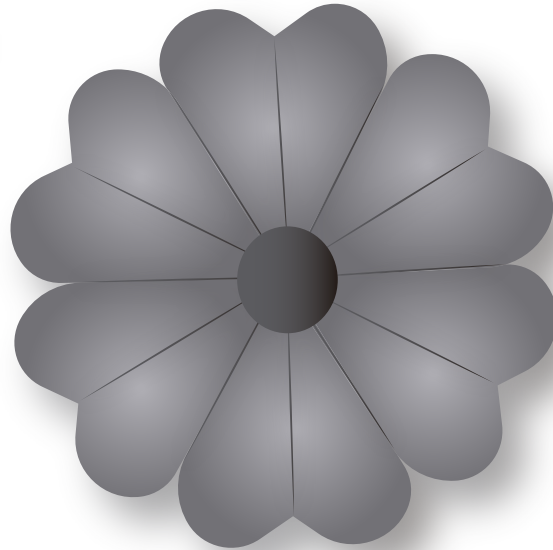

CHAPETON MEGA
6 1/2" Ø

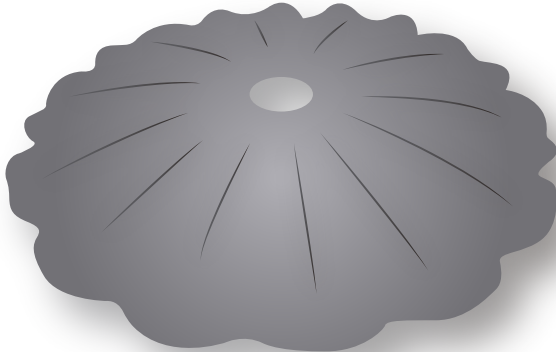

CHAPETON INVERTIDO
3 3/4" Ø

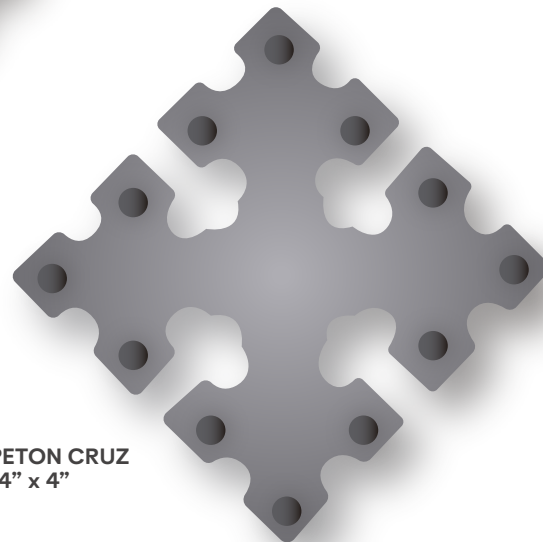

CHAPETON CRUZ
4" x 4"





CHAPETONES DECORATIVOS

CHAPETON AGUILA
126.0 x 21.1 cms.
(Calibre 18)

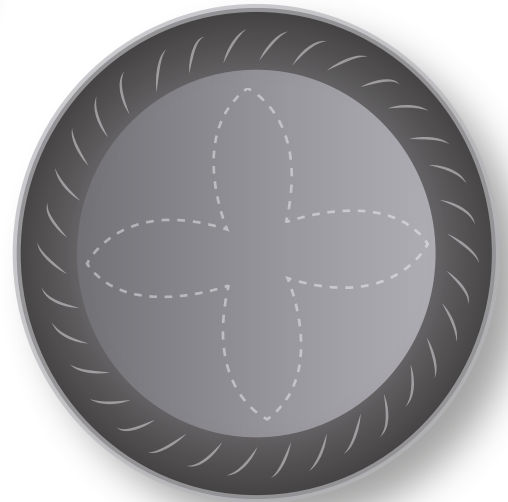

CHAPETON CHARRO
12.0 y 16.0 cms. Ø
(Calibre 20)

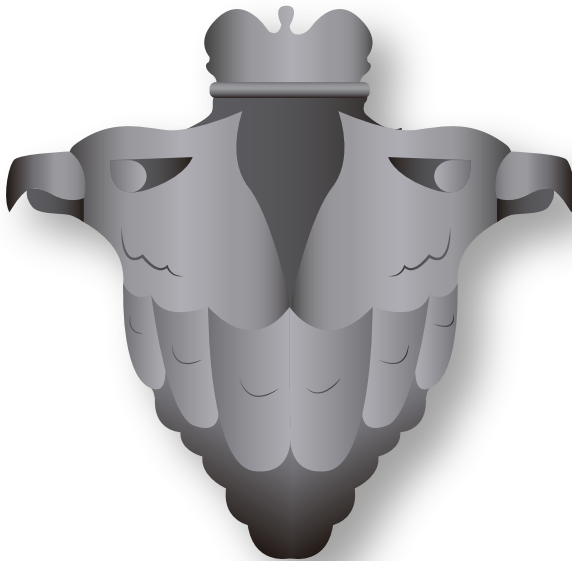

CHAPETON HALCON
12.0 x 11.5 cms.
(Calibre 18)

CHAPETON VIVA MEXICO
16.0 cms. Ø
(Calibre 20)





CHAPETONES DECORATIVOS

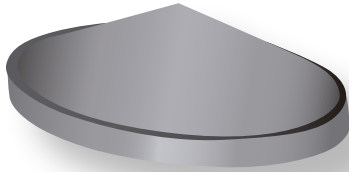

CHAPETON KISS
(Negro y Latonado)
2" Ø
(calibre 20)

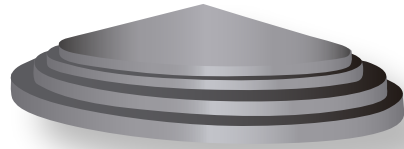

CHAPETON CHOPO CHICO
(Negro y Latonado)
1 1/2" Ø
(calibre 20)

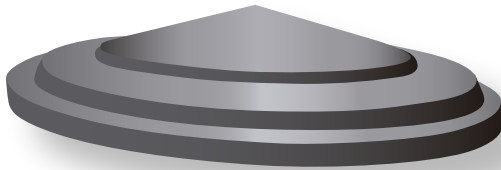

CHAPETON CHOPO GRANDE
(Negro y Latonado)
2" Ø
(calibre 20)

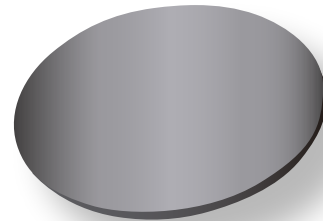

REMACHE COLONIAL
1 7/8" Ø
(calibre 18)



COMAL
19 9/16" X 9 9/16"
(calibre 14)



PLACA
(Negro y Latonado)
11 x 13 5/8"
(calibre 14)





HERRAJES DECORATIVOS

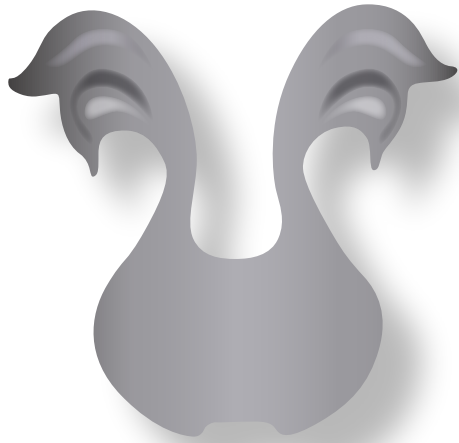

ALAS DE CISNE
9.43 x 9.87 cms.



ALAS DE SERAFIN
18.5 x 8.0 cms.

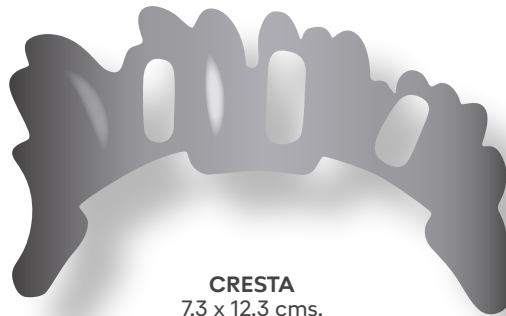

CRESTA
7.3 x 12.3 cms.



ABIERTO
8.4 x 7.0 cms.

TULIPAN



CERRADO
6.7 x 5.8 cms.





PLANOS DECORATIVOS

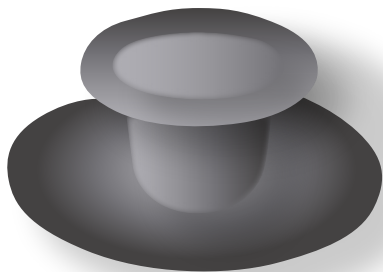

CON BASE
1 3/16" x 1"

PORTA VELA

(calibre 20)

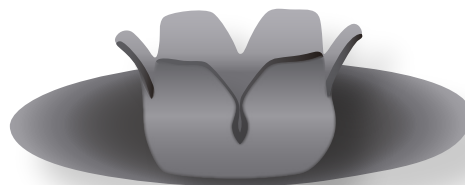

CON ESFERAS
2 5/8" Ø

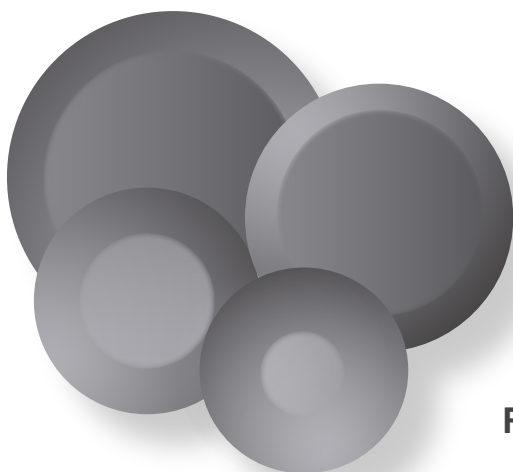

PLATOS

Nombre	Medida
Plato No. 1	2 5/8"
Plato No. 2	3 1/2"
Plato No. 3	4"
Plato No. 4 Hondo	5 5/8"
Plato No. 5 Extendido	5 5/8"
Plato No. 6	4 1/2"
Plato No. 7	5"
Plato No. 8	6"

Plato No. 1	Calibre 20
Plato No. 2, 3, 4, 5, 6, 7 y 8	Calibre 18

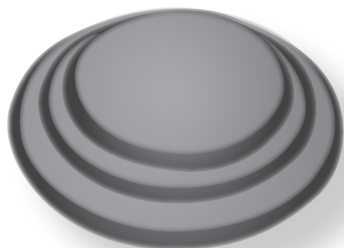

PLATOS BASE

Base	Medida	Calibre
Plato No. 9	6"	20
Plato No. 10	8"	20
Plato No. 11	10"	20

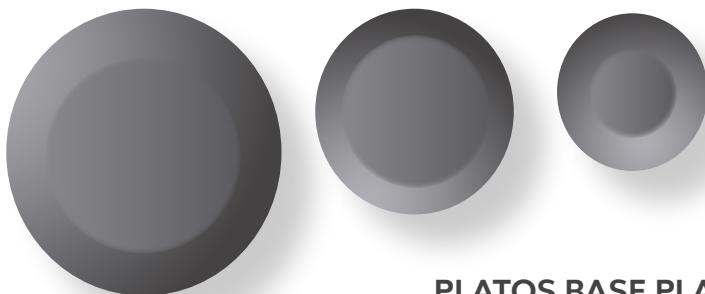

PLATOS BASE PLANA

Base	Medida	Calibre
Plato No. 12	1 1/2"	18
Plato No. 13	2"	18
Plato No. 14	3"	18





HERRAJES DECORATIVOS



TREBOL RENACIMIENTO
Laminado de 12.0 y 16.0 cms.
(calibre 14)



TREBOL
12.0 cms. (calibre 1/8")
16.0 cms. (calibre 3/16")

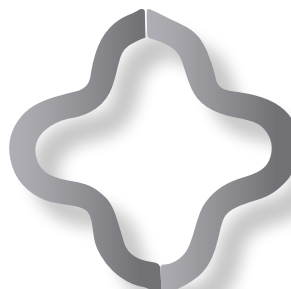

TREBOL FORJADO
12.0 cms.
(calibre 1/2")

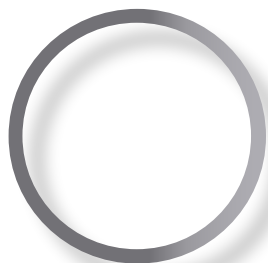

ARO
12.0 cms. Ø (calibre 1/8")
14.0 cms. Ø (calibre 1/8" y 3/16")
16.0 cms. Ø (calibre 3/16")



ARO AZTECA
12.0 y 16.0 cms. Ø
(calibre 1/8")



FIG. COLONIAL
Laminado de 12.0 y 16.0 cms.
(calibre 14)



ARO CRUZ
12.0 cms. Ø (calibre 1/8")
14.0 cms. Ø (calibre 1/8" y 3/16")
16.0 cms. Ø (calibre 3/16")

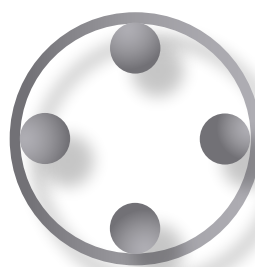

ARO CON ESFERA
12.0 cms. Ø (calibre 1/8")
14.0 cms. Ø (calibre 1/8" y 3/16")
16.0 cms. Ø (calibre 3/16")

0123456789

NÚMEROS
2 1/2" De alto (calibre 14)





HERRAJES DECORATIVOS

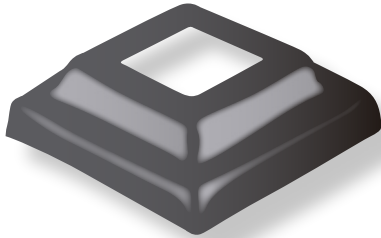

CUELLO LAMINADO DE 1/2"
 1 1/2" x 1 1/2" 
 (calibre 20)

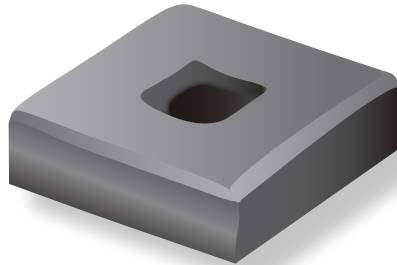

CUELLO FORJADO
 1/2" x 5/8" 
 (calibre 1/2")

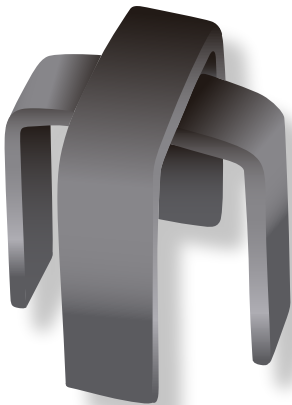

NUDO CRUZ
 4.0 X 3.8 cms.
 (calibre 12)

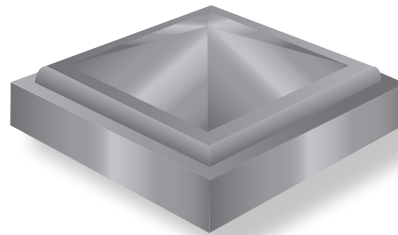

TAPA LAMINADA
 1", 1 1/4", 1 1/2" y 2"
 (calibre 20)



**SUPER PORTA
 PROTECTOR**
 3" x 2 9/16"
 (calibre 14)

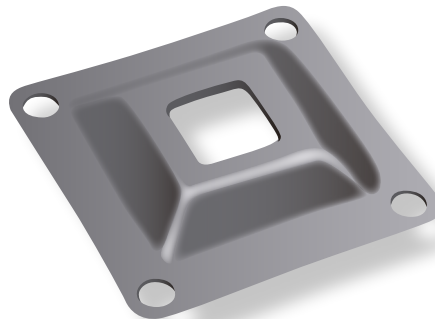

SUPER ZAPATO
 4" x 4" X 1/2"
 Para PTR de
 1" y 1 1/4"
 (calibre 14)





PASADORES

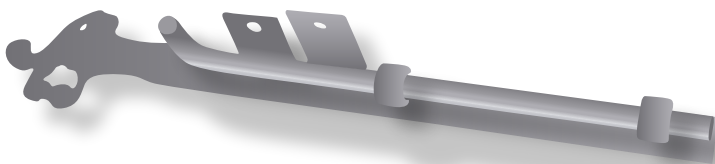

PICAPORTE AZTECA
14 3/4" x 2 5/8"
(calibre 11)

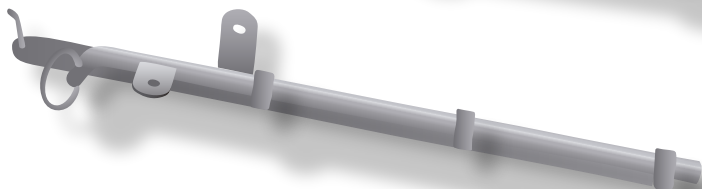

PICAPORTE
12", 16" Y 22"
(calibre 8)

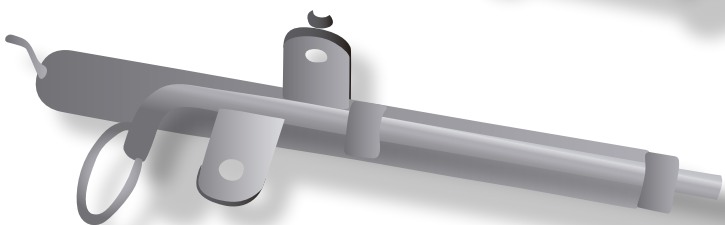

**PICAPORTE
MARTILLADO**
12"
(calibre 8)

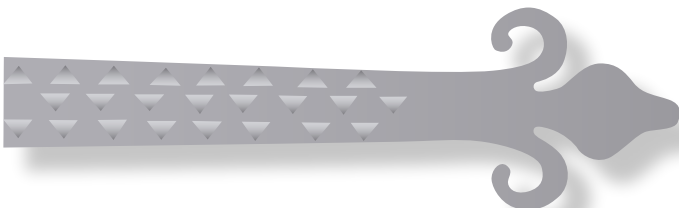

**VISTA DE BISAGRA
COLONIAL**
9.0 x 50.5 cms.

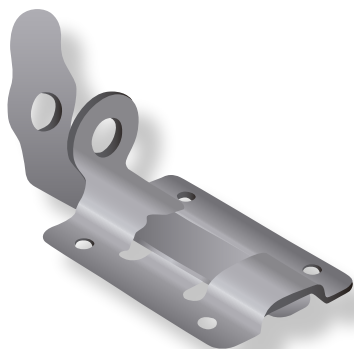

PASADOR BROCHE
5.4 x 3.8 cms.

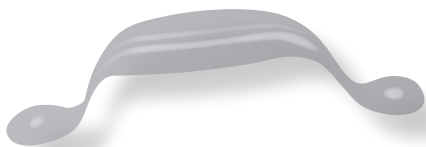

JALADERA
15.7 x 3.2 cms.
(calibre 20)

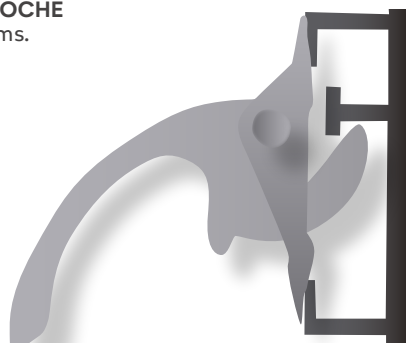

SEGURO PARA VENTANA
(Base calibre 18)
(Gancho calibre 9)





FIERRO VACIADO

CLAVE 245A

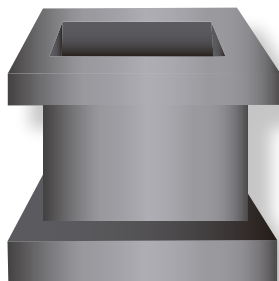

CUELLO AZTECA
∅ 1/2"

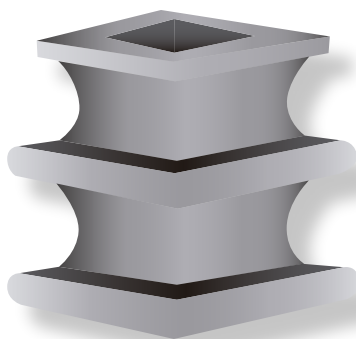

CLAVE 246

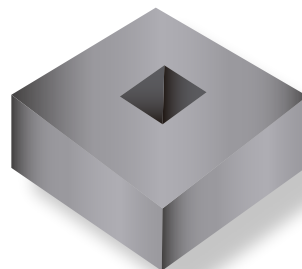

CUELLO PLANO
∅ 1/2"

CLAVE 251V

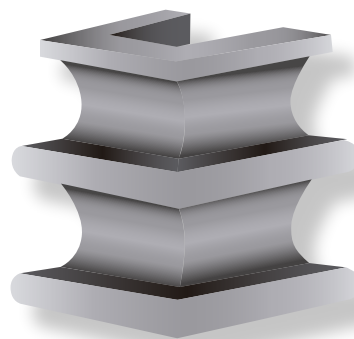

MEDIO CUELLO
VERTICAL
∅ 1/2"

CLAVE 256

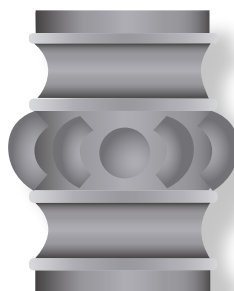

CUELLO
NAPOLITANO
∅ 1/2", 5/8"

CLAVE 252

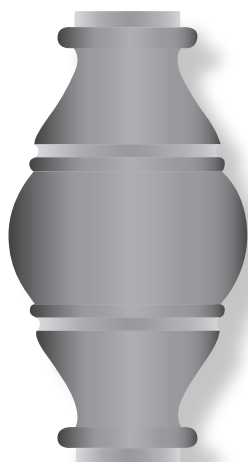

CUELLO DE
BOTELLA
∅ 1/2"

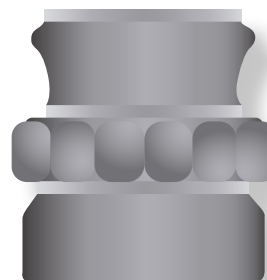

REMATE
NAPOLITANO
∅ 5/8"





FIERRO VACIADO

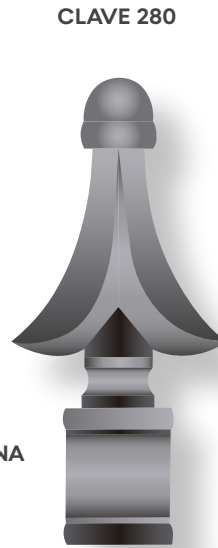
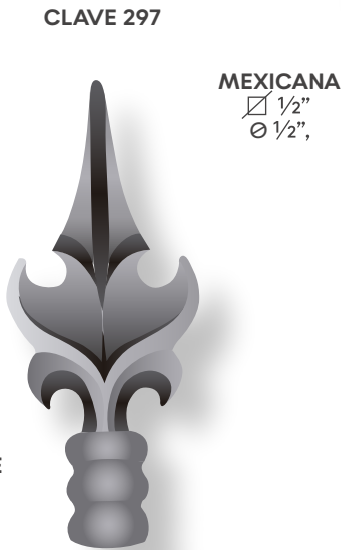
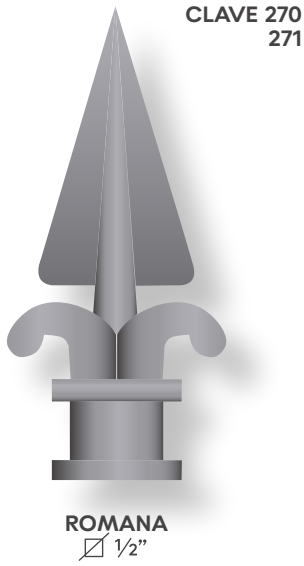



ACECO



Matriz:

Maximino Ávila Camacho No. 503-A
Col Barrio El santuario, Tepeaca, Puebla

☎ 800 - 001 - 2232 (ACEC)

Sucursal Tehuacán;
Blvd. Adolfo López Mateos No. 4227,
Col. San Lorenzo Teotipilco, Tehuacan, Puebla.

☎ 800 - 001 - 2232 (ACEC)

Sucursal Acatzingo
Boulevard 3 Poniente No. 1737,
Col. El Trebol, Acatzingo, Puebla.

☎ 800 - 001 - 2232 (ACEC)

Sucursal San Martín:
Carretera Federal San Martín Tex- Huejotzingo Km 94.5,
Colonia San Juan Tuxco, San Martín Texmelucan, Puebla.

☎ 800 - 001 - 2232 (ACEC)

Sucursal Ciudad Serdán
Avenida Revolución No. 1007, Colonia Centro,
Ciudad Serdán, Puebla

☎ 800 - 001 - 2232 (ACEC)

Sucursal Atlixco:
Carretera Federal Puebla- Izucar de MATAMOROS Km 29
Col. Lomas de Tejaluca, Atlixco, Puebla.

☎ 800 - 001 - 2232 (ACEC)

Sucursal San Salvador El Seco:
Calle 2 de Abril No.35 San Salvador el seco ,Puebla,

☎ 800 - 001 - 2232 (ACEC)

Sucursal San Lorenzo Ometepec:
Carretera Ixcaquixtla Km 12.5, San Lorenzo Ometepec, Puebla

☎ 800 - 001 - 2232 (ACEC)

Sucursal Tlapa de Comonfort:
Carretera Federal Tlapa- Chilapa Km. 1.3
Col. Los Zapotales Tlapa de Comonfort, Guerrero.

☎ 800 - 001 - 2232 (ACEC)

Sucursal Apizaco:
Desiderio Hernández Xochiteotzin No. 509
Col. Del Carmen, Apizaco, Tlaxcala

☎ 800 - 001 - 2232 (ACEC)

Sucursal Cuautla;
Carretera Mexico-Oaxaca No. 3017,
Col. Hermenegildo Galeana, Cuautla, Morelos

☎ 800 - 001 - 2232 (ACEC)

www.aceco.com.mx